



Republic of the Philippines  
**SOUTHERN LUZON STATE UNIVERSITY**  
Lucban, Quezon

**REQUEST FOR QUOTATION**

**PROPOSED BUSINESS STALL FOR BAO STALL #3 (BAO)**

**Purchase Request No. 2024-04-0926**  
**Approved Budget for the Contract: ₱400,000.00**

The Southern Luzon State University through the Bids and Awards Committee invites interested firms/supplier to submit quotation for the procurement of **Proposed Business Stall for BAO Stall #3 (BAO)** to apply the sum of **Four Hundred Thousand Pesos Only (₱ 400,000.00)** inclusive of VAT, being the **Approved Budget for the Contract (ABC)**, details as follows:

Qty.	Unit	ITEM/S DESCRIPTION
1	unit	Construction of Stall 3
		Proposed 1 Unit Business Stall SLSU-BAO (Stall #3)

1. The quotation must be submitted (can also be send thru email at the contact details listed below) or to the Office of the Procurement Office/Bids and Awards Committee, Southern Luzon State University, 2<sup>nd</sup> Flr. Hermano Pull Building, and shall be received by the Committee.

E-mail : [sisuprocurement@slsu.edu.ph](mailto:sisuprocurement@slsu.edu.ph)

2. The SLSU reserves the right to reject any or all quotations and/or proposals and waive any formalities/ informalities therein and to accept such bids it may consider as most advantageous to the agency and to the government. Southern Luzon State University SLSU neither assumes any obligation for whatsoever losses that may be incurred in the preparation of bids, nor does it guarantee that an award will be made.

**MARIDEL C. ZABELLA**  
Head, Procurement Office  
Southern Luzon State University  
Lucban, Quezon  
Tel. No.: (042)540-6519



Republic of the Philippines  
SOUTHERN LUZON STATE UNIVERSITY  
Planning and Development Office  
Lucban, Quezon

PROJECT TITLE: Proposed Business Stall for BAO (Stall #3)  
PROJECT LOCATION: Brgy. Kulapi, Lucban Quezon  
OWNER : Southern Luzon State University  
ABC : P 400,000.00  
PROJECT DURATION : 45 CD  
PROJECT BRIEF DESCRIPTION : One Storey Commercial Bldg.

**SUMMARY**

ITEM	DESCRIPTION	COST OF MATERIALS	COST OF LABOR AND EQUIPMENT	TOTAL
I	General Works			
II	Earthworks			
III	Reinforced Concrete Works			
IV	Masonry Works			
V	Form Works and Scaffolding			
VI	Electrical Works			
VII	Doors and Windows			
VIII	Plumbing & Sanitary			
X	Celling Works			
XI	Truss and Tinsmithry Works			
XII	General Finishes			
		<b>TOTAL ESTIMATED DIRECT COST P</b>		
		<b>OVERHEAD, CONTINGENCIES &amp; MISC. (OCM) P</b>		
<b>INDIRECT COST</b>		<b>CONTRACTOR'S PROFIT P</b>		
		<b>VALUE ADDED TAX (VAT) P</b>		
		<b>TOTAL PROJECT COST P</b>		

*Note : Painting Works are excluded*

TOTAL COST IN WORDS : \_\_\_\_\_

CONTRACTOR / BIDDER : \_\_\_\_\_

<b>BUSINESS AFFAIRS OFFICE</b>	
<b>RECEIVED</b>	
Date:	MARCH 08, 2024
Time:	04:28 PM
By:	GERARD SALAYONG <i>[Signature]</i>

*[Handwritten Signature]*

Republic of the Philippines  
SOUTHERN LUZON STATE UNIVERSITY  
Planning and Development Office  
Lucban, Quezon

PROJECT TITLE: Proposed 1 Unit Business Stalls SLSU-BAO (Stall #3)  
PROJECT LOCATION: Brgy. Kulapi, Lucban Quezon  
OWNER : Southern Luzon State University  
MODE OF IMPLEMENTATION : by Contract  
PROJECT DURATION: 45 CD  
PROJECT BRIEF DESCRIPTION : One Storey Commercial Bldg.

**BILL OF MATERIALS**

I. General Works (General Requirements)				
Quantity	Unit	Description	Unit Cost	Total Cost
	lot	Mobilization / Demobilization		
	lot	Project Identification & Signs, Tarpaulin with Marine Plywood Backing/ Building Permits up to Certificate of Completion		
	lot	Soil Poisoning		
	lot	Temporary Facilities and Enclosure		
	lot	Material Testing		
	lot	Safety Program and Policy		

Sub - Total P

II. Earthworks				
Quantity	Unit	Description	Unit Cost	Total Cost
	cu.m.	Earthfill/backfill		
	cu.m.	Gravel bedding		
	sq.m	Clearing and Grubbing		
	lot	Hauling and Disposal		
	lot	Compaction and Grading		
	cu.m.	Excavation		

Sub - Total P

III. Reinforced Concrete Works				
Quantity	Unit	Description	Unit Cost	Total Cost
	bags	Portland Cement		
	cu.m.	Sand S1		
	cu.m.	Gravel 3/4"		
	pcs	12mm dia RSB x 6m		
	pcs	10mm dia RSB x 6m		
	kgs	G.I. Tie Wire #16		
	lot	Consumables		

Sub - Total P

IV. Masonry Works				
Quantity	Unit	Description	Unit Cost	Total Cost
	pcs	CHB 5"		
	bags	Portland Cement		
	cu.m.	Sand		
	pcs	10 mm dia RSB x 6m		
	kgs	G.I. Tie Wire #16		
	lot	Consumables		

Sub - Total P

V. Form Works and Scaffolding Works				
Quantity	Unit	Description	Unit Cost	Total Cost
	bd.ft	coco lumber		
	pcs	1/2"x4'x8' Phenolic Board		



	kg	Assorted Nail		
--	----	---------------	--	--

Sub - Total P

**VI. Electrical Works**

Quantity	Unit	Description	Unit Cost	Total Cost
	m	20mm dia. PVC Flexible Pipe Conduit		
	pcs	20mm dia. PVC Pipe Conduit		
	pcs	25mm dia. PVC Pipe Conduit		
	pcs	20mm dia PVC Elbow		
	roll	2.0 sq.mm THHN Wire		
	roll	3.5 sq.mm THHN Wire		
	m	5.5 sq.mm THHN Wire		
	pcs	PVC Junction Box		
	pcs	PVC Utility Box		
	pcs	2 Gang Convenience Outlet		
	pcs	4" Receptacle		
	pcs	2-Gang Switch		
	pcs	1-Gang Switch		
	pcs	LED Bulbs 9 watts		
	pcs	2-20w Mirrorized Casing LED Fluorescent Lamp with diffuser		
	pcs	Panel Board, Plug-in Type Main 2P, 30AT		
		Branches : 2P,15AT -2pcs, 2P, 20-4pcs		
	pcs	15 A, 2P Circuit Breaker Plug-In -Electric		
	pcs	20 A, 2P Circuit Breaker Plug-In -Electric		
	pcs	30 AT, 2P Main Circuit Breaker Plug-In -Electric		
	pcs	RSC Pipe 25mm dia. x 3.0m		
	pcs	Service Entrance Cap 25mm dia. 3.0m		
	pcs	PVC Pipe 25mm dia. x 3.0m		
	pcs	Metal Clamp 1/2" hole		
	pcs	GI Bushing 1"x1/2" dia.		
	pcs	PVC Adaptor 1"		
	pcs	Metal Clamp 1/2" hole		
	pcs	Ground Rod 5/8"		
	pcs	Meter Base		
	lot	Consumables		

Sub - Total P

**VII. Doors and Windows**

Quantity	Unit	Description	Unit Cost	Total Cost
	set	1/4"thk Aluminum Sliding Window Powder Coated (0.60m x 1.2m)		
	set	1/4"thk Aluminum Sliding Window Powder Coated (0.60m x 0.60m)		
	set	PVC Doors (0.60m x 2.10m) for toilet		

Sub - Total P

**VIII. Plumbing and Sanitary Works (Sanitary and waterline works)**

Quantity	Unit	Description	Unit Cost	Total Cost
	lot	<i>Drainage Line</i>		
	pcs	PVC Pipe 4" (drainage pipe)		
	pcs	PVC Wye 4"x4"		
	pcs	PVC Elbow 4" x 45 deg.		
	pcs	PVC Elbow 4" x 90 deg.		
	pcs	4" PVC Clean Out		
	pcs	PVC Tee 2" x2" dia.		
	pcs	P-trap		
	pcs	PVC Wye 2"x4"		
	pcs	PVC Tee 4"x4"		
	can	PVC Solvent Cement		
	ltrs	Vulcaseal		
	lot	<i>Waterline</i>		

	pcs	1/2" x 3.0m uPVC Pipe		
	pcs	1/2" PPR Elbow		
	pcs	1/2" PPR Tee		
	pcs	1/2" PPR Male Adaptor		
	set	Plumbing Fixtures		
		Others		
	lot	Consumables		

Sub - Total P

#### XI. Ceiling Works (Carpentry Works)

Quantity	Unit	Description	Unit Cost	Total Cost
	pcs	Fiber Cement Board 4mm thk 4ftx8ft		
	pcs	Double Metal Furrings @ 0.4mx0.60m		
	pcs	Wall Angles 1x1x8'		
	pcs	Carrying Channel (12mm x38mmx5m @0.60 spacing)		
	lot	Consumables		

Sub - Total P

#### XII. Truss and Tinsmithry Works (Roofing Works)

Quantity	Unit	Description	Unit Cost	Total Cost
	pcs	3/16" thk Channel bar 2" x 4" x 2"		
	pcs	2" x 3" G.I. C-Purlins 1,20mm thk		
	pcs	10mm dia. Plain Round Bar		
	pcs	1/2" thk x 12" x 8' Fascia Board		
	lm	Long Span Rib-Type Pre-painted 0.5thk x 1.05 width		
	pcs	Stainless Gutter 8ft long 0.60mm thk		
	pcs	0.50mm x 0.610m x 2.40m Prepainted Flashing		
	lot	Consumables (Tekscrew, Sealant, Epoxy paint, Paint Brush, Welding Rods)		

Sub - Total P

#### XIII. General Finishes

Quantity	Unit	Description	Unit Cost	Total Cost
		<i>Floor &amp; Wall Tiles</i>		
	pcs	12mm thk 60cm x 60cm Floor Tiles		
	pcs	12mm thk 40cm x 40cm Wall Tiles		
	bags	Portland Cement		
	cu.m	Sand S1		
	bags	Tile Adhesive		
	kgs	Tile grout		

Sub - Total P

Republic of the Philippines  
Southern Luzon State University  
Planning & Development Office  
Lucban, Quezon

OFFICE OF THE PRESIDENT	
RECEIVED	
Date:	2/26/24
Time:	9:40 AM
[Signature]	

**PROJECT TITLE :** Proposed 1 Unit Business Stall SLSU-BAO (Stall #3)  
**PROJECT LOCATION :** Brgy. Kulapi, Lucban Quezon  
**OWNER :** Southern Luzon State University  
**PROJECT DURATION :** 45 CD (Except Sundays & Holidays)

### SCOPE OF WORKS

#### I. GENERAL REQUIREMENTS

- Mobilization / Demobilization
- Project Identifications, Signs and Building Permit
- Soil Poisoning
- Material Testing
- Safety Program & Policy

#### II. EARTHWORKS

- Clearing & Grubbing
- Excavation
- Gravel Bedding
- Earthfill & Backfill

#### III. REINFORCED CONCRETE WORKS

- Concreting of all structural elements as plan, following NSCP Standard.

#### IV. MASONRY WORKS

- Laying of concrete hollow blocks with even textures and well defined edges, all masonry works shall provide with 10mm diameter reinforcing bars.
- Masonry finishes shall be smooth plaster finish unless otherwise specified.
- Plastering of both faces of walls as per standard and minimum thickness as required.
- Finish shall be smooth.

#### V. FORMWORKS SCAFFOLDINGS

- The works include the construction and installation of formworks and scaffoldings. Fabrication of column/beam forms and erection of forms and scaffolding and dismantling/stripping of forms.

#### VI. STEEL RAFTER AND ROOFING WORKS

- Weld all shop assembled connections continuous without undercut and distortion of rafter.
- Grind and or dress exposed welds smooth and flush to corner or fillet without weakening the connections.
- Splices and expansion joints shall utilize internal splice connectors with set screws to allow for expansion over ambient temperature change.
- Roofing materials to be installed shall be brand new and must conform with specifications according to plans or approved equivalent by the supervising engineer.

#### VII. ELECTRICAL WORKS

- All electrical works shall provide all materials and equipment and perform all the works necessary for the complete execution of the electrical system shown on the electrical drawings with reference to the general construction drawings as herein specified, or both except as otherwise excluding the generality of the foregoing shall include but not limited to the following principal items of the works.
- Supply and installation of electrical fixtures.
- Supply and installation of electrical wire and cables.
- Supply and Installation of electrical pipe line.
- Power supply for the building shall be connected to the existing power house of the university.
- All materials and equipment to be installed shall be approved quality and should be presented to Southern Luzon State University/Representative Engineer for approval prior to installation.
- All materials shall be new and shall conform to the reference code and standard. Use of mtl's shall furfure be governed by the other requirements, imposed on the specification. Materials shall be subjected to test, if necessary, for their fitness if so required.
- All outlets shall be supplied and install.

#### VIII. SANITARY WORKS

- All plumbing works included herein shall be executed according to the provision of the National Plumbing Code of the Philippines, National Building Code and the rules and regulation of the city/province.
- Supply and installations of sanitary and plumbing fixtures.
- Supply & Installations of sewer pipe line and water drain.
- Sanitary Pipes to connect to the existing Septic tank of IGS Bldg.
- All materials and equipment to be installed shall be approved quality and should be presented to SLSU/Representative Engineer for approval prior to installation.
- All materials shall be new and shall conform to the reference Code and Standard. Use of materials shall furfure be governed by other requirements, imposed on the specification. Materials shall be subjected to test, if necessary, for their fitness if so required.

#### IX. GENERAL FINISHES

- Ceiling works – Supply and installation of ceiling in metal framing at store, comfort room, lobby (only specify in plan), corridor/halfway and around the perimeter.
- Tile works – Installation of 40cm x 40cm floor tiles and 40cm x 40cm wall tiles & 60cm x 60cm for store area.
- Door & Windows – Supply and installation of doors & windows the plan specifies.

Prepared by:

  
Imelda B. Villaflo  
Assistant Planning Engr.

Recommending Approval:

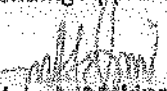
  
Engr. Melvin A. Makipagay  
Director, Planning & Development Office  
Infrastructure Planning/Works/Project Dev.

Approved by:

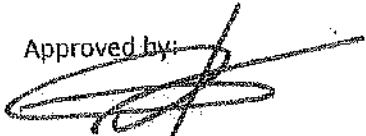
  
Dr. Nilo H. Dator  
OIC, University President



- Legend:**
- 1 - Modern Active Building (College of Arts and Sciences)
  - 2 - John P. Ricci Building (College of Arts and Sciences)
  - 3 - Kennedy Park Building
  - 4 - Veterans Park Park
  - 5 - SLSU Chapel
  - 6 - Hill Building
  - 7 - Comstock Building (College of Business Administration)
  - 8 - Garcia Aguirre Building (College of Business Administration)
  - 9 - SLSU Administration Building
  - 10 - Andres Borelino Building (College of Industrial Technology / College of Tourism Studies)
  - 11 - Alvarez K. Don Juan Building (College of Engineering)
  - 12 - College of Engineering Laboratory
  - 13 - SLSU Open Field
  - 14 - Business Center
  - 15 - Gymnasium
  - 16 - Shopper Office
  - 17 - SLSU Church Deck
  - 18 - Parking Space - Vehicular Deck
  - 19 - SLSU Gymnasium
  - 20 - SLSU Library
  - 21 - Dormitory
  - 22 - Primary School
  - 23 - Tennis Court
  - 24 - Laboratory High School Baseball Court
  - 25 - Laboratory Night School

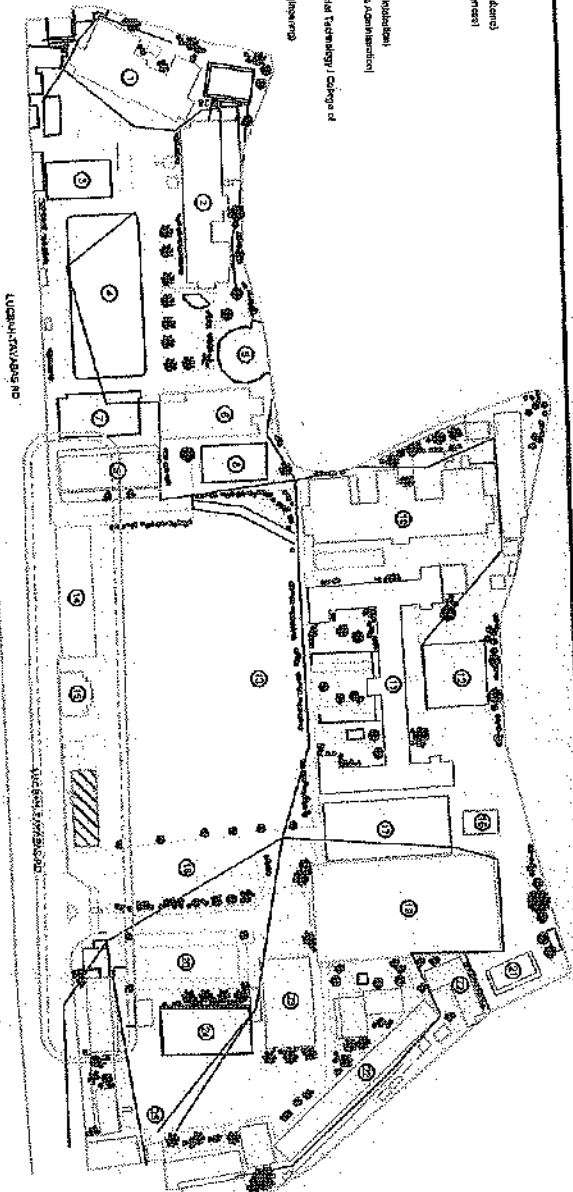

**1**  
A-1  
**SITE DEVELOPMENT PLAN**

SCALE: AS SHOWN



**2**  
A-1  
**LOCATION MAP**

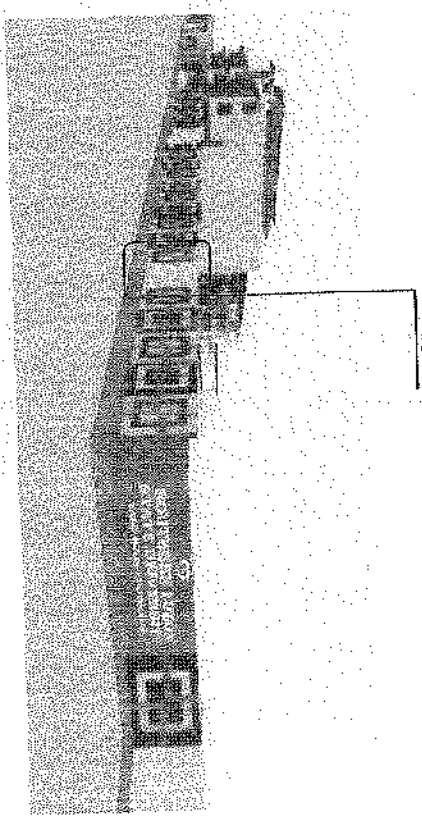

**3**  
A-1  
**PERSPECTIVE**



CIVIL STRUCTURAL ENGINEER		PROJECT TITLE		DRAWN BY		CHECKED BY		DATE	
PROPOSED BUSINESS STALL (etail #9)		SLSU-BAO		MIRANDA B. VILLALBA		MIRANDA B. VILLALBA		10/15/2010	
RECOMMENDING APPROVAL		APPROVED BY		SHEET CONTAINS:		SHEET NO.		DATE	
ENGR. MIRANDA B. VILLALBA		MIRANDA B. VILLALBA		A-1		01		2010	

ISS BUILDING WALL

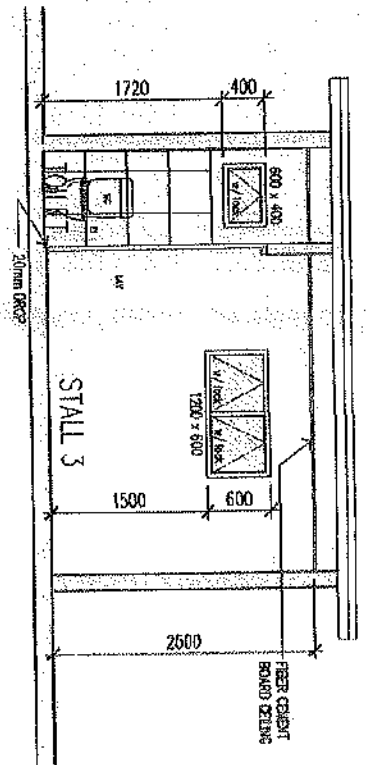
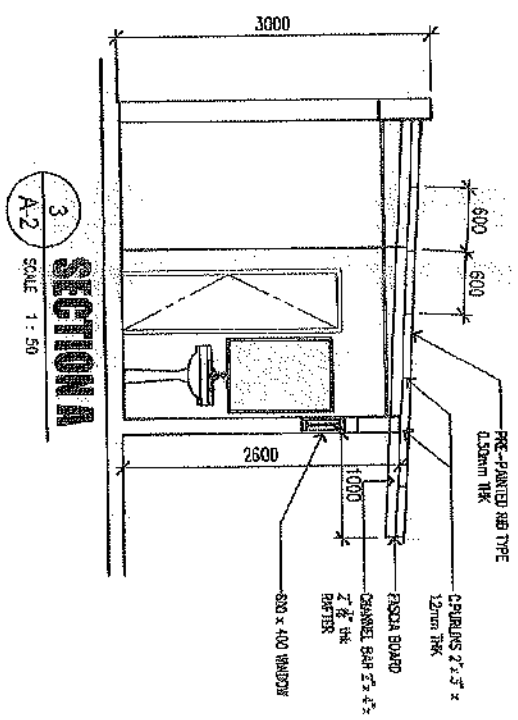
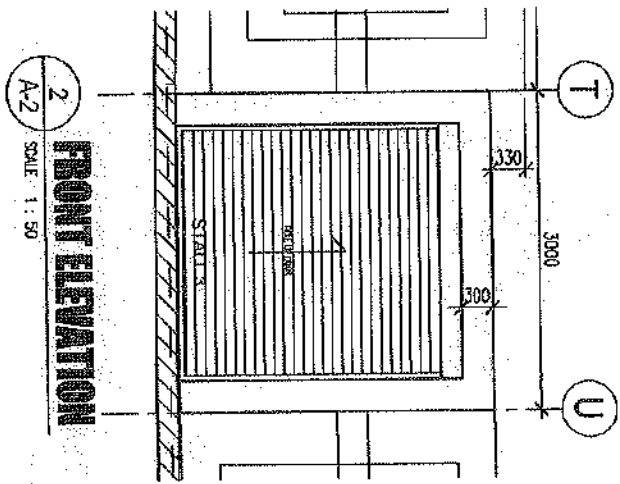
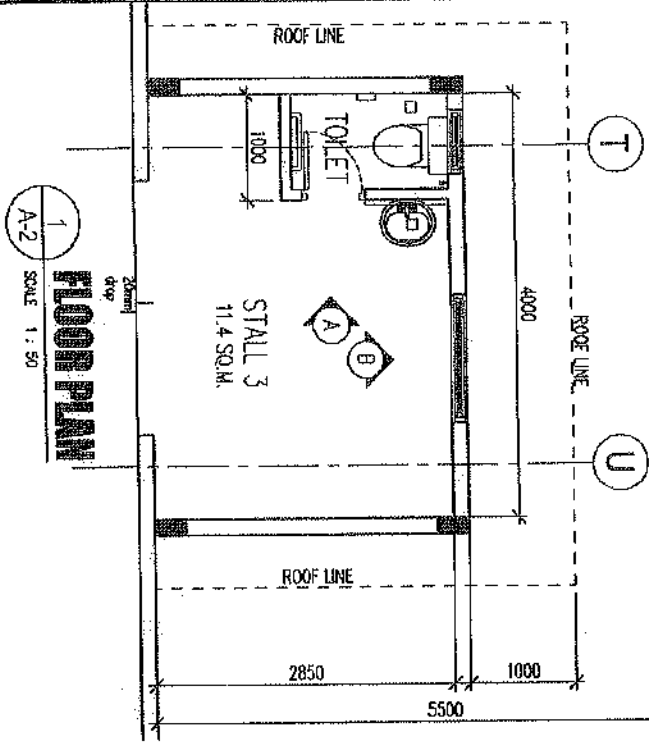

CIVIL (STRUCTURAL) ENGINEER NAME: [Redacted] NO. [Redacted]	PROJECT TITLE <b>PROPOSED BUSINESS STALL (stall #3)</b> SLSU BAO	DRAWN BY NAME: [Redacted] NO. [Redacted]	CHECKED BY NAME: [Redacted] NO. [Redacted]	APPROVED BY NAME: [Redacted] NO. [Redacted]	SHEET NO. <b>A-2</b> OF <b>02</b>
PROJECT TITLE <b>PROPOSED BUSINESS STALL (stall #3)</b> SLSU BAO	DRAWN BY NAME: [Redacted] NO. [Redacted]	CHECKED BY NAME: [Redacted] NO. [Redacted]	APPROVED BY NAME: [Redacted] NO. [Redacted]	SHEET NO. <b>A-2</b> OF <b>05</b>	



CIVIL STRUCTURAL ENGINEER

PROJECT TITLE:

PROPOSED BUSINESS STALL (Stall #3)  
ST. SU. BAO

DESIGNED BY:

NELSON E. VILLAFIOR

REVIEWED BY:

RECOMMENDING APPROVAL:

ENGR. MEL VINCE T. MANABAY  
DIRECTOR PLANNING AND DESIGN

APPROVED BY:

DR. M. O. H. DATOR  
CHIEF UNIVERSITY ENGINEER

SHEET CONTENTS:

A-3

03 03

1  
A-3

# FLOOR FINISH LAYOUT

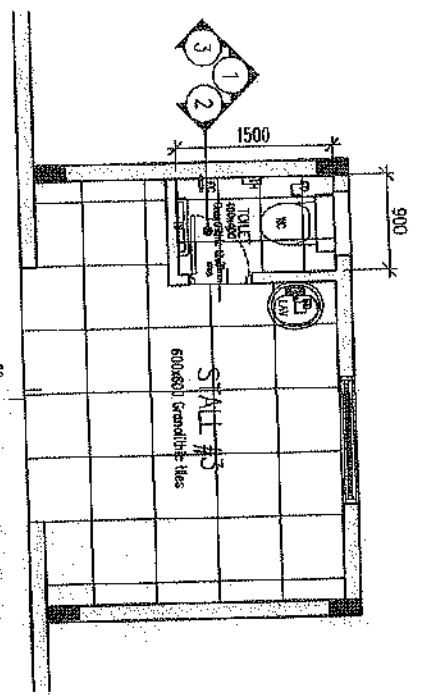

2  
A-3

# SECTION 1

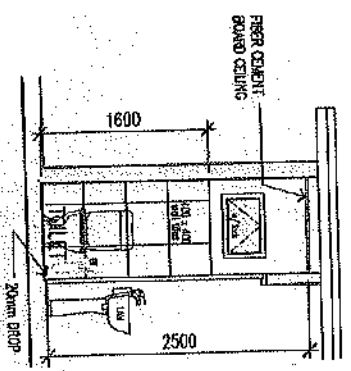

3  
A-3

# SECTION 2

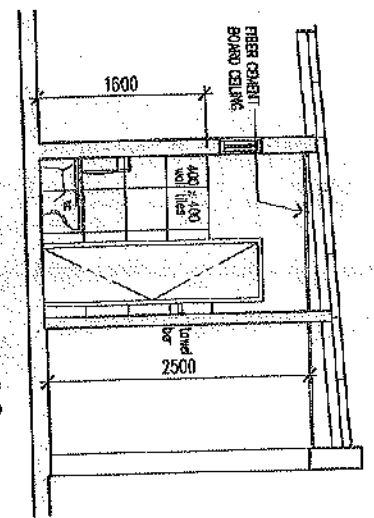

4  
A-3

# SECTION 3

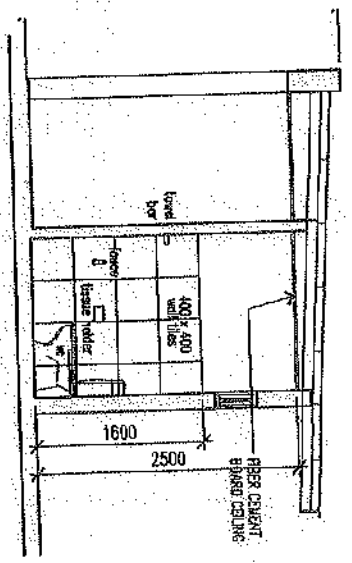

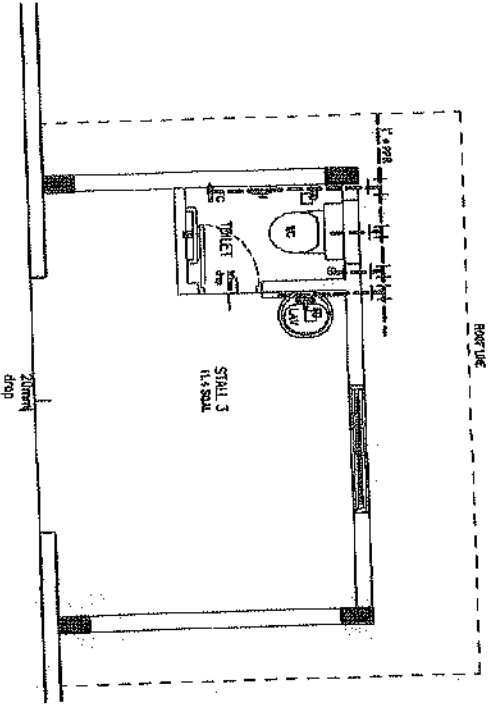

1  
P-1 SCALE 1:50  
**COLD WATERLINE LAYOUT**

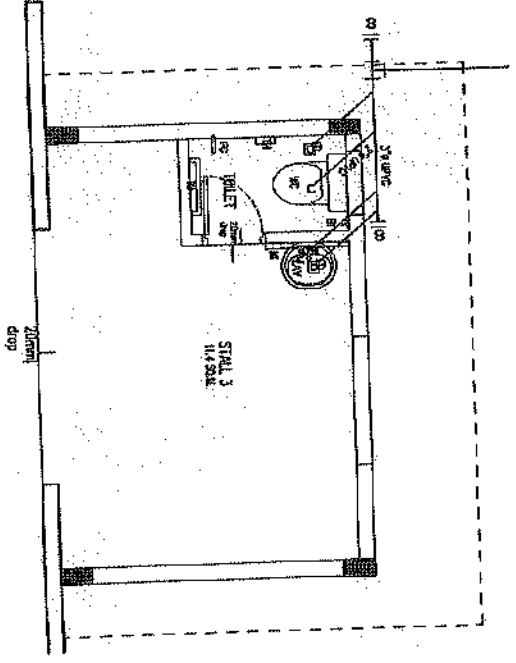

2  
P-1 SCALE 1:50  
**SANITARY LINE LAYOUT**

- LEGEND :
- COLD WATER LINE
  - SANITARY LINE
  - LAVATORY
  - FLOOR DRAIN
  - WATER CLOSET
  - BIDET
  - TISSUE HOLDER
  - FAUCET
  - TOWEL BAR
  - MIRROR
  - LAV
  - FD
  - WC
  - BI
  - TH
  - FC
  - TB
  - MI



CIVIL / STRUCTURAL ENGINEERS		PROJECT TITLE		DRAWN BY		CHECKED BY		DATE	
PROPOSED BUSINESS STALL (STALL #3)		SLSU-SAO		JHEIDA B. VILLAFLOR		ENGR. MELVIN A. MANSANGAN		01/01/2020	
PAIRED BY		REVIEWED BY		RECOMMENDING APPROVAL		APPROVED BY		SHEET CONTENTS	
JHEIDA B. VILLAFLOR		ENGR. MELVIN A. MANSANGAN		ENGR. MELVIN A. MANSANGAN		ENGR. MELVIN A. MANSANGAN		P-1	
OPERATOR: ENGR. MELVIN A. MANSANGAN		OPERATOR: ENGR. MELVIN A. MANSANGAN		OPERATOR: ENGR. MELVIN A. MANSANGAN		OPERATOR: ENGR. MELVIN A. MANSANGAN		01/01/2020	



CIVIL / STRUCTURAL ENGINEER

PROJECT TITLE

PROPOSED BUSINESS STALL (stall #4)

DESIGNED BY

MELINDA E. WILLARD

REVIEWED BY

RECOMMENDING APPROVAL

ENGR. MELVIN S. MADRAGAY

APPROVED BY

DR. H. H. DATOR

SHEET CONTENTS:

E-1

01

08

1  
E-1

SCALE 1 : 50

# ELECTRICAL LIGHTING LAYOUT

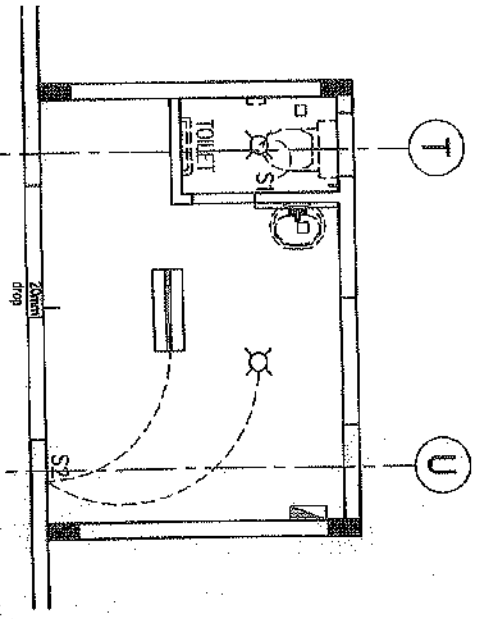

## ELECTRICAL LEGEND

- SERVICE ENTRANCE
- KILOWATT HOUR METER
- LIGHTING OUTLET
- FLUORESCENT LIGHT
- CONVENIENCE OUTLET
- PANEL BOARD
- CIRCUIT HOME RUN
- SINGLE POLE SWITCH
- DOUBLE POLE SWITCH
- TRIPLE POLE SWITCH

2  
E-1

SCALE 1 : 50

# ELECTRICAL POWER LAYOUT

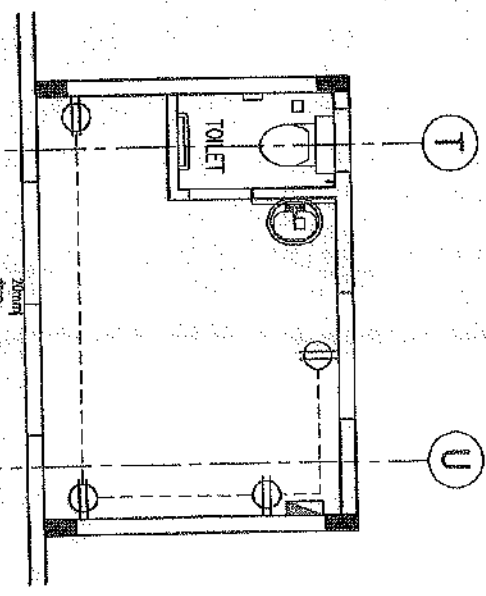





CIVIL / STRUCTURAL ENGINEER

PROJECT TITLE

PROPOSED BUSINESS STALL (SMALL K9)

PLANNED BY

IRENEIDA B. VILLAFLOR

REVIEWED BY

MAURICIO GARCIA

RECOMMENDING APPROVAL

ENGR. MEDINA ALVARADO

APPROVED BY

IRVING Y. CANTOR

SHEET CONTENTS

S-2

2

# CILING FRAMING PLAN

SCALE 1 : 25

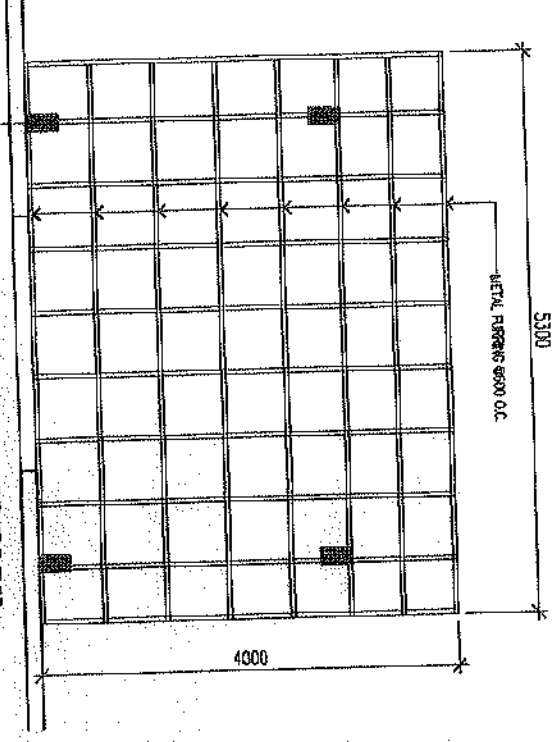

1

# FOUNDATION PLAN

SCALE 1 : 50

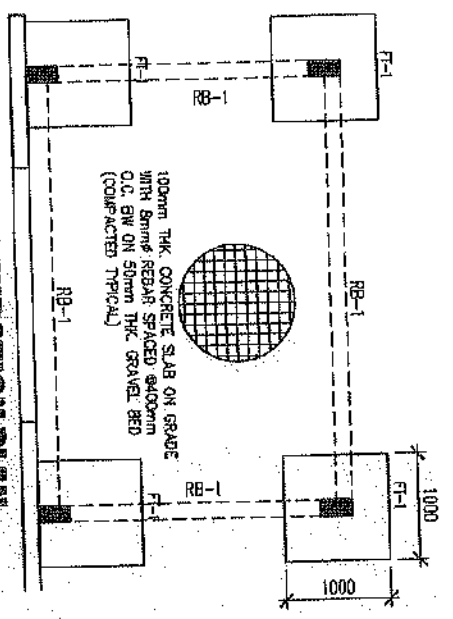

3

# ROOF FRAMING PLAN

SCALE 1 : 50

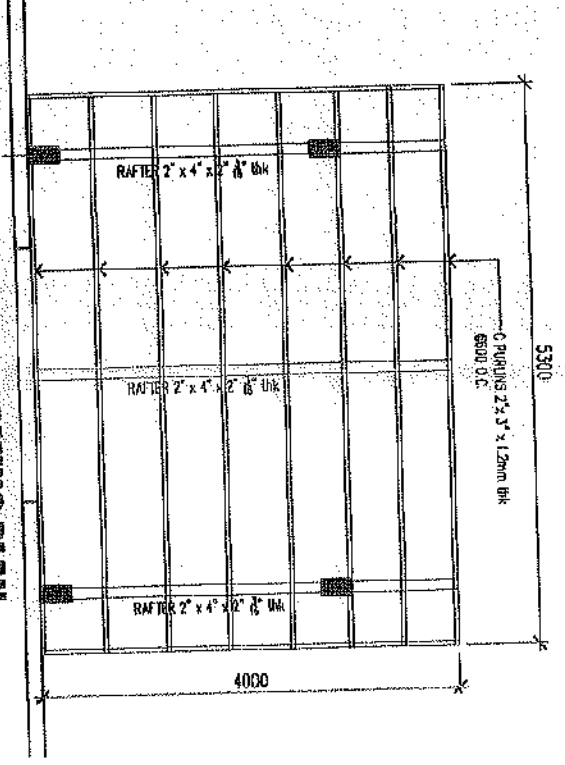

4

# RAFTER DETAILS

SCALE 1 : 50

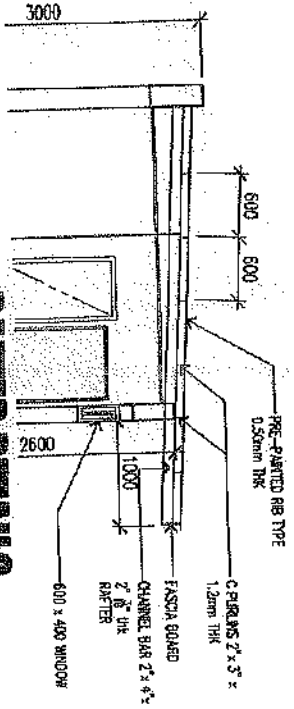

02 02